

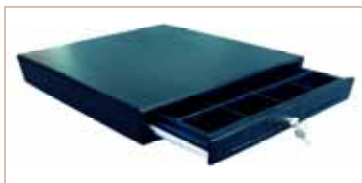

# GIANT SAFES



[WWW.GIANTSAFES.COM](http://WWW.GIANTSAFES.COM)

## Guide to all Products

Page

B-RATED SECURITY CHEST .....	16
CASH DRAWERS & CASH BOXES.....	30-31
DATA SAFES .....	9
DEPOSIT SAFES .....	13-15
FIRE & BURGLARY SAFES BFB SERIES .....	5
FIRE & BURGLARY SAFES FB & HS Series .....	3-4
FIRE-PROOF FILING CABINETS .....	9
FIRE RESISTANT SAFES .....	6-8
GUN SAFES .....(Fire and Fire & Burglary).....	22-23
HOTEL & ELECTRONIC SAFES.....	21
IN-FLOOR SAFES.....	19-20
KEY BLANKS.....	34
KEY CONTROL .....	26-29
PADLOCKS.....	32-33
SAFE LOCKS .....	24-25
UNDER COUNTER SAFES.....	17
UL-TL15 LISTED .....	10
UL-TL30 LISTED .....	11
UL-TL-30x6 LISTED .....	12
WALL SAFES.....	18

**NOTE:**

Colours and Sizes in the Catalogue may not be exactly as shown. Measurements are approximate and may change without notice.



# FB SERIES

## FIRE & BURGLARY

The Brawn® VULCAN SERIES offers an ingenious design offering all the security features of a Burglar Safe and the peace of mind achieved with a fire safe



### Fire & Burglary FB Series Common Features

- 3-3/4" Thick door consisting of 1/4", and two 1/8" thick steel plates with 2" of fire insulation
- 2" Thick body consisting of 1/8" thick, inner and outer steel plates with 1-3/4" of fire insulation
- One recessed bolt down hole with cover and Bolt down hardware included
- Tempered glass reloading and spring loaded devices
- Heavy duty solid steel block ball bearing hinges
- **Class 350 degree, 2 hour fire MFG label**
- Intumescent door seal when exposed to high temperature expands to as much as 8 times its thickness
- 3 mm V shape harden Anti-drill steel plate to protect side punch attack to the bolt works
- Supplied with UL Group II combination or electronic lock
- Comes standard with your choice of Chrome LP Electronic lock or Dial Combination Lock

#### FB-2017C / 2017E

Outside  
Inside  
Weight  
Shelf

H 20.5", W 17.4", \*D 18.8"  
H 15", W 11.8", D 11"  
250 Lbs.  
2

\*(Add 2" for handle & dial lock)



#### HS 2214C/2214E

Many of the same features as the FB series, however because of its compact size the bolt works are smaller and there is no glass relocker

Outside  
Inside  
Shelf  
Weight

H 22", W 14", \*D 16"  
H 18.6", W 11", D 10.5"  
2 (Adjustable)  
180 Lbs.

\*(Add 2" for handle & lock)



#### FB-2221C / 2221E

Outside  
Inside  
Weight  
Shelf

H 22.2", W 21.7", \*D 21.7"  
H 17.3", W 16", D 14.8"  
414 Lbs.  
2

\*(Add 2" for handle & dial lock)



#### FB-2621C / 2621E

Outside  
Inside  
Weight  
Shelf

H 26.2", W 21.7", \*D 21.7"  
H 21", W 16", D 15"  
457 Lbs.  
2

\*(Add 2" for handle & dial lock)



#### Additional Lock Options For FB Series

LP Electronic

S+G 6730 Combination

S+G Key locking Dial

LP EL-25 Time Delay

LP EL-30 Dual custody

LaGard Basic

LaGard Safe Gard

# FB SERIES

## FIRE & BURGLARY

Brawn® offers an ingenious design offering all the security features of a Burglar Safe and the peace of mind achieved with a fire safe



### FB-4021C / 4021E



Outside  
Inside  
Weight  
Shelf

H 40", W 21.7", \*D 21.7"  
H 35.2", W 16, D 14.8"  
628 Lbs.  
3  
\*(Add 2" for handle & dial lock)

### FB-4525 C / 4525 E



Outside  
Inside  
Weight  
Shelf

H 45.5", W 25.5", \*D 27.5"  
H 40.25", W 20", D 23.5"  
776 Lbs.  
4  
\*(Add 2" for handle & dial lock)

### Chrome and Faux Leather Custom Interior

### CFB-3421C / 3421E



Outside  
Inside  
Weight  
Shelf

H 34", W 21.7", \*D 21.7"  
H 28.5", W 16, D 13.5"  
518 Lbs.  
2  
\*(Add 2" for handle & dial lock)

### Chrome and Faux Leather Custom Interior

### CFB-4021C / 4021E



Outside  
Inside  
Weight  
Shelf

H 40", W 21.7", \*D 21.7"  
H 35.2", W 16, D 14.8"  
628 Lbs.  
3  
\*(Add 2" for handle & dial lock)

# BFB SERIES FIRE & BURGLARY SAFES

C = Changeable Combination Lock  
E = Electronic Lock



## BFB SERIES COMMON FEATURES

- Class 350 degree, 2 hour fire MFG label
- Composite construction: 2.2" thick door & 3" thick body
- Independent glass plate relocking device for BFB-685+
- 1.26" diameter active bolts work in three directions
- Predrilled anchor hole with hardware included
- Comes standard with your choice of Chrome LP Electronic lock or Dial Combination lock

### BFB-450C/ 450E

Outside H 17.7", W 20", \*D 20.5"  
 Inside H 11.6", W 14", D 13"  
 Shelf 1 (Adjustable)  
 Moving Front Bolts 2  
 Top / Bottom Moving Bolts -/  
 Weight 243 Lbs.  
 \*(Add 2" for handle & lock)



### BFB-845C/ 845E

Outside H 33.3", W 21", \*D 22.7"  
 Inside H 27.3", W 15", D 15.3"  
 Shelf 2 (Adjustable)  
 Moving Front Bolts 3  
 Top / Bottom Moving Bolts 1/1  
 Weight 440 Lbs.  
 \*(Add 2" for handle & lock)



### BFB-685C/ 685E

Outside H 27", W 21", \*D 20.5"  
 Inside H 21", W 15", D 13"  
 Shelf 2 (Adjustable)  
 Moving Front Bolts 3  
 Top / Bottom Moving Bolts 1/1  
 Weight 355 Lbs.  
 \*(Add 2" for handle &

lock)



### BFB-1054C/ 1054E

Outside H 41.5", W 28", \*D 29"  
 Inside H 35.5", W 22", D 27.5"  
 Shelf 2 (Adjustable)  
 Moving Front Bolts 4  
 Top / Bottom Moving Bolts 1/1  
 Weight 750 Lbs.  
 \*(Add 2" for handle & lock)



## Additional Lock Options For BFB series

- LP Electronic
- BO-DL Combination
- S+G Key locking Dial
- LP EL-25 Time Delay
- LP EL-30 Dual custody
- LaGard Basic
- LaGard Safe Gard

## BFB extra shelves

- Shelf 450
- Shelf 685
- Shelf 845

# 1 HOUR FIRE RESISTANT SAFES

1 Hour 350° rating  
 1700°  
 1200°  
 Average House Fire  
 450°  
 Paper chars  
 350° Interior of Safe



## 310 SERIES

Outside H 12.1", W 16.5", \*D 14"  
 Inside H 8", W 12.4", D 9.3"  
 Weight 83 Lbs.  
 Tray 1  
 \*(Add 2" for dial lock)  
 One bolt down hole

### Key Locking BS-K310



### Combination Lock & 3 Spindle Handle BS-D310



### Digital Lock & Thumb Turn BS-T310



## 360 SERIES

Outside H 14.2", W 19.3", \*D 16.7"  
 Inside H 9.3", W 15", D 9.3"  
 Weight 126 Lbs.  
 Tray 1  
 \*(Add 2" for dial lock)  
 One bolt down hole

### Combination Lock & 3 Spindle Handle BS-D360



### Digital Lock & Thumb Turn BS-T360



## 500 SERIES

Outside H 19.7", W 13.8", \*D 16.7"  
 Inside H 15", W 9.3", D 12.1"  
 Weight 152 Lbs.  
 Tray / Shelf 1/1  
 \*(Add 2" for dial lock)  
 One bolt down hole

### Combination Lock & 3 Spindle Handle BS-D500



### Digital Lock & Thumb Turn BS-T500





# 2-HOUR FIRE RESISTANT SAFES



## 610 SERIES

Outside H 22", W 17.7", \*D 18.1"  
 Inside H 16.6", W 12.7", D 12.2"  
 Weight 176 Lbs.  
 Tray / Shelf 1/1

\*(Add 2" for handle)

Combination w/Key Lock **BS-C610**



Digital w/Key Lock **BS-T610**



## 750 SERIES

Outside H 27", W 20.9", \*D 20"  
 Inside H 21.25", W 15.3", D 13.6"  
 Weight 297 Lbs.  
 Drawer / Shelf 1/1

\*(Add 2" for handle)

Combination w/Key Lock **BS-C750**



Digital w/Key Lock **BS-T750**



## 670 SERIES

Outside H 24", W 19.7", \*D 18.5"  
 Inside H 18.5", W 14.2", D 12.2"  
 Weight 220 Lbs.  
 Drawer / Shelf 1/1

\*(Add 2" for handle)

Combination w/Key Lock **BS-C670**



Digital w/Key Lock **BS-T670**



## 880 SERIES

Outside H 32", W 23.2", \*D 20"  
 Inside H 26.2", W 17.5", D 13.6"  
 Weight 374 Lbs.  
 Drawer / Shelf 1/1

\*(Add 2" for handle)

Combination w/Key Lock **BS-C880**



Digital w/Key Lock **BS-T880**



Note: All 2HR fire safes come with removable castors

# UL <sup>2</sup>-HOUR FIRE RESISTANT SAFES



## Combination & Key Lock **BS-C1000**

Outside H 36.8", W 23.6", \*D 21"  
 Inside H 30.5", W 17.6", D 14.2"  
 Weight 440 Lbs.  
 Drawer / Shelf 1/2  
 \*(Add 2" for handle & dial lock)



## Combination & Key Lock **BS-C1200**

Outside H 43.8", W 27.6", \*D 25"  
 Inside H 37.2", W 20.9", D 18.1"  
 Weight 572 Lbs.  
 Drawer / Shelf 1/2  
 \*(Add 2" for handle & dial lock)



## Combination & Key Lock **BS-C1400**

Outside H 55.1", W 27.6", \*D 25"  
 Inside H 45", W 20.9", D 18.1"  
 Weight 704 Lbs.  
 Drawer / Shelf 1/3  
 \*(Add 2" for handle & dial lock)



## Combination & Key Lock **BS-C1700**

Outside H 64", W 31.5", \*D 25"  
 Inside H 56.9", W 24.8", D 18.1"  
 Weight 1,034 Lbs.  
 Drawer / Shelf 1/3  
 \*(Add 2" for handle & dial lock)



## Combination & Key Lock **BS-C1750**

Outside H 67.5", W 45.3", \*D 25"  
 Inside H 56.9", W 38.6", D 18.1"  
 Weight 1,650 Lbs.  
 Drawer / Shelf 2/3  
 \*(Add 2" for handle & dial lock)



DOUBLE-DOOR SAFE

## Extra Shelves (complete with clips)

- Shelf 610
- Shelf 670
- Shelf 750
- Shelf 880
- Shelf 1000
- Shelf 1200
- Shelf 1400
- Shelf 1700
- Shelf 1750

## Lock Options For 2-Hour Fire Resistant Safes

- BO-DL Combination
- LP Electronic EL-20
- LP EL-25 Time Delay
- LP EL-30 Dual custody
- LaGard Basic
- LaGard Safe Gard



# FIRE-PROOF FILING CABINETS



# DATA SAFES

## Common Features:

- Heavy duty drawer suspension slides work smoothly , capable of up to 50 kg loads
- One changeable dial or electronic locks all drawers, separate key lock on each drawer.
- **2-hour heating endurance test, drop test and reheating test under the fire proof inspection provisions**
- 1.6mm steel plate thickness coated with antirust primer

### BIF-200C/200T

- 2-drawer filing cabinet

Outside H 30.3", W 21.25", D 26.8"  
 Weight 372 Lbs.  
 Drawer size H 11.3", W 15.3", D 20.5"

Legal Size  
Drawer



BIF-200T  
(Black)



BIF-200C

### BIF-300C/300T

- 3-drawer filing cabinet

Outside H 44.25", W 21.25", D 26.8"  
 Weight 537 Lbs.  
 Drawer size H 11.3", W 15.3", D 20.5"



BIF-300C



BIF-300T  
(Black)



Legal Size  
Drawer

### BIF-400C / 400T

- 4-drawer filing cabinet

Outside H 58.25", W 21.25", D 26.8"  
 Weight 700 Lbs.  
 Drawer size H 11.3", W 15.3", D 20.5"



BIF-400C



BIF-400T  
(Black)



Legal Size  
Drawer

### Combination & Key Lock

### BDS-610D

Outside H 24", W 17.7", \*D 18.1"  
 Inside H 12.4", W 8.5", D 7.8"  
 Weight 216 Lbs.  
 Shelf 1  
 \*(Add 2" for handle & dial lock)



### Combination & Key Lock

### BDS-880D

Outside H 34.7", W 23.2", \*D 20"  
 Inside H 21.8", W 13.1", D 9.5"  
 Weight 457 Lbs.  
 Shelf 2  
 \*(Add 2" for handle & dial lock)



### Combination & Key Lock

### BDS-1000D

Outside H 39.4", W 23.6", \*D 21"  
 Inside H 26.1", W 13.1", D 9.6"  
 Weight 541 Lbs.  
 Shelf 3  
 \*(Add 2" for handle & dial lock)



# UL-TL15 Listed Composite Fire & Burglary

- UL TL-15 certified
- UL certified Group 2M manipulation resistant combination lock with spy proof dial
- Full composite construction comprised of the highest quality barrier material enclosed within heavy steel plates.
- Sophisticated glass relock system activates massive re-lockers when attacked
- Bolts inter-lock within reinforced bolt chambers
- Heavy plate steel frame
- High quality adjustable hinges
- **2 hours fire resistance**
- Custom interiors available



**TL 15**



**2 HOUR**

*\*\* Specifications may not be exactly as listed*

Model Name	Interior			Exterior			Volume (ft. <sup>3</sup> )	Weight (lbs.)
	Height (in.)	Width (in.)	Depth (in.)	Height (in.)	Width (in.)	Depth (in.)		
TL15 1212	12	12	10	17	17	19 ½	0.83	430
TL15 2014	20	14 ½	15	25	19	23 ¼	2.52	725
TL15 2517	25	17 ½	15	30	22	23 ½	3.80	880
TL15 3219	32	19 ½	17	37	24	25 ¼	6.14	1177
TL15 4520	45	20 ½	21	50	25	30	11.21	1716
TL15 5520	55	20 ½	21	60	25	30 ¼	13.70	2200
TL15 6523	65	23	21	70	28	30 ½	18.17	2585
TL15 6532	65	32	21	70	37	30 ½	25.28	3216
TL15 7242	72	42	21	77	47	30 ½	36.75	4269

# UL-TL30 Listed Composite Fire & Burglary

- UL TL-30 certified
- UL certified Group 2M manipulation resistant combination lock with spy proof dial
- Full composite construction comprised of the highest quality barrier material enclosed within heavy steel plates
- Sophisticated glass relock system activates massive relockers when attacked
- Bolts inter-lock within reinforced bolt chambers
- Heavy plate steel frame
- High quality adjustable hinges
- **2 hours fire resistance**
- Custom interiors available



**TL30**



**2 HOUR**

*\*\* Specifications may not be exactly as listed*

Model Name	Interior			Exterior			Volume (ft. <sup>3</sup> )	Weight (lbs.)
	Height (in.)	Width (in.)	Depth (in.)	Height (in.)	Width (in.)	Depth (in.)		
TL30 1212	12	12	10	17	17	19 ¼	0.83	490
TL30 2014	20	14 ½	15	25	19	23 ¼	2.52	964
TL30 2517	25	17 ½	15	30	22	23 ½	3.80	1202
TL30 3219	32	19 ½	17	37	24	25 ¼	6.14	1595
TL30 4520	45	20 ½	21	50	25	30	11.21	2326
TL30 5520	55	20 ½	21	60	25	30 ¼	13.70	2806
TL30 6523	65	23	21	70	28	30 ½	18.17	3356
TL30 6532	65	32	21	70	37	30 ½	25.28	4119
TL30 7242	72	42	21	77	47	30 ½	36.75	5399

# UL-TL30x6 Listed Composite Fire & Burglary

- UL TL-30×6 certified
  - UL certified Group 2M manipulation resistant combination lock with spy proof dial
  - Full composite construction comprised of the highest quality barrier material enclosed within heavy steel plates
  - Sophisticated glass relock system activates massive relockers when attacked
  - Bolts inter-lock within reinforced bolt chambers
  - Heavy plate steel frame
  - High quality adjustable hinges
  - **2 hours fire resistance**
- Custom interiors available



**2 HOUR**

*\*\* Specifications may not be exactly as listed*

Model Name	Interior			Exterior			Volume (ft. <sup>3</sup> )	Weight (lbs.)
	Height (in.)	Width (in.)	Depth (in.)	Height (in.)	Width (in.)	Depth (in.)		
TL30x6 2014	20	14 ½	15	28	22 ½	26	2.52	1323
TL30x6 2517	25	17 ½	15	33	25 ½	26	3.80	1685
TL30x6 3219	32	19 ½	17	40	27 ½	28	6.14	2221
TL30x6 4520	45	20 ½	21	53	28 ½	32	11.21	3240
TL30x6 5520	55	20 ½	21	63	28 ½	32	13.70	3716
TL30x6 6523	65	23	21	73	31	32	18.17	4512
TL30x6 6532	65	32	21	73	40	32	25.28	5474
TL30x6 7242	72	42	21	80	50	32	36.75	7095

# CASH DEPOSITORY SAFES

## Common Features

- 1/2" thick door with 1/4" thick body
- Solid steel plate door, recessed for maximum protection
- Formed "B" rate steel plate body
- Bolt down holes
- Add 2" for handle & dial lock

### B 1414S

Outside H 14", W 14", \*D 14"  
 Inside H 13.5", W 13.5", D 11.3"  
 Weight 88 Lbs.  
 Deposit H 0.5", W 5.5"



### B 2020S/2020SE

Outside H 20.5", W 20.5", \*D 20"  
 Inside (Top) H 8.8", W 19", D 16"  
 Inside (Bottom) H 11", W 19.5", D 17"  
 Weight 196 Lbs.  
 Shelf 1  
 Deposit H 0.8", W 4.3"



### FL 1614C/1614E

- 3 mm body, 12 mm door and 6 mm deposit drawer
- Full length dead bar
- Spring loaded reloading device
- 2—1.25" Dia chrome plated live locking bolts
- Available in dial, digital or key lock

Outside H 16", W 14", \*D 14"  
 Inside H 6.3", W 13.8", D 11.3"  
 Weight 115 Lbs.  
 Deposit H 3.8", W 10.8"

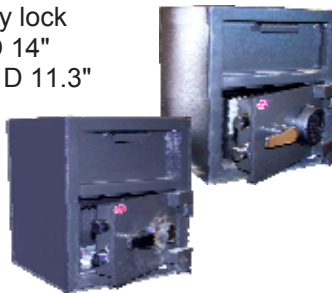

### Additional Lock Options for available

- LP Electronic
- S+G 6730 Combination
- S+G Key locking Dial
- LP EL-25 Time Delay
- LP EL-30 Dual custody
- LaGard Basic II

### Dial / Digital / Double Nose Key Lock

### FL 2714 / 2714K

Outside H 27", W 14", \*D 14"  
 Inside H 17.5", W 13.8", D 11"  
 Weight 130 Lbs.  
 Deposit H 3.5", W 11.5"  
 Shelf 1 (Adjustable)  
 \*(Add 2" for handle & dial lock)

### Without inner compartment



### FL 2714-IC

Outside H 27", W 14", \*D 14"  
 Inside Top H 9.8", W 13.8", D 9.8"  
 Inside Bottom H 10.5", W 13.5", D 11.5"  
 Weight 141 Lbs.  
 Deposit H 2.8", W 10.3"  
 \*(Add 2" for handle & dial lock)

### With inner compartment



### FL 2014C / 2014E

- 6 mm body, 12 mm door and 6 mm deposit drawer
- Full length dead bar
- Spring loaded reloading device
- 3—1.25" Dia chrome plated live locking bolts
- Available in dial and digital lock

Outside H 20", W 14", \*D 14"  
 Inside H 11", W 13", D 10"  
 Weight 143 Lbs.  
 Deposit H 4", W 11"  
 \*(Add 2" for handle & dial lock)  
 (Our most popular deposit safe)



# CASH DEPOSITORY SAFES

**FL 2720**

Outside H 27", W 19", \*D 22"  
 Inside H 17.5", W 18.5", D 18.8"  
 Weight 207 Lbs.  
 Shelf 1 (Adjustable)  
 Deposit H 3.5", W 15.5"  
 \*(Add 2" for handle and dial lock)

**Without inner compartment**



**FL-4019-IC**

Outside H 40", W 19", \*D 22"  
 Inside (Top) H 6", W 18.5", D 18"  
 Inside (Bottom) H 24", W 18.5", D 19"  
 Weight 485 Lbs.  
 Shelf 2 (Adjustable)  
 Deposit H 2.5", W 15.5"  
 \*(Add 2" for handle & dial Lock)

**With inner compartment**



**FL 2720-IC**

Outside H 27", W 19", \*D 22"  
 Inside (Top) H 15", W 18", D 17"  
 Inside (Bottom) H 10.5", W 18.5", D 19"  
 Weight 238 Lbs.  
 Deposit H 2.5", W 15.8"  
 \*(Add 2" for handle & dial Lock)

**With inner compartment**



**FL 3414 / 3414EE**

Outside H 34", W 14", \*D 14"  
 Inside (Top) H 10", W 13.5", D 11.3"  
 Inside (Bottom) H 14.5", W 13.5, D 11.3"  
 Weight 190 Lbs.  
 Deposit H 3.5", W 11.3"  
 \*(Add 2" for handle & dial)



**FL 3016-IC**

Outside H 30", W 16", \*D 19"  
 Inside (Top) H 12", W 15.5", D 16"  
 (Bottom) H 16.3", W 15.5", D 14"  
 Weight 207 Lbs.  
 Shelf 1 (Adjustable)  
 Deposit H 3.5", W 13.5"  
 \*(Add 2" for handle and dial lock)

**With inner compartment**



**MB 3321**

Outside H 33", W 21", \*D 21"  
 Inside Top H 12", W 20.5", D 17.5"  
 Inside Bottom H 12", W 20.5", D 17.5"  
 Weight 355 Lbs.  
 Deposit H 3", W 18.5"  
 \*(Add 2" for handle and dial lock)



# CASH DEPOSITORY SAFES

## FL 3020

Outside H 30", W 20", \*D 16"  
 Inside (Top) H 11", W 19.5", D 13.5"  
 Inside (Bottom) H 12", W 19.5", D 13.5"  
 Weight 227 Lbs.  
 Deposit H 3.5", W 16.5"  
 \*(Add 2" for handle & dial lock)



## RH 2012

Outside H 21", W 13", \*D 14.5"  
 Inside H 14", W 12.5", D 10.3"  
 Weight 124 Lbs.  
 Deposit H 4.3", W 9.5"  
 \*(Add 4" for rotary hopper handle)

### Top Loading Safes



## RL 2818C

Outside H 28", W 18", \*D 20"  
 Inside H 27.5", W 17.5", D 17.5"  
 Shelf 1 (Adjustable)  
 Weight 220 Lbs.  
 Deposit H 3.5", W 15"  
 \*(Add 2" for handle & dial lock)

### Rear Load Safe



## RH 2818 / 2818K

Outside H 28", W 15", \*D 17"  
 Inside H 19", W 12", D 16"  
 Weight 203 Lbs.  
 Deposit H 5.5", W 10.5"  
 \*(Add 4" for rotary hopper handle)



# B-Rated SAFES

- 1/2" thick A36 solid steel plate door, recessed for maximum protection
- Formed "B" rate steel plate body
- Bolt down holes

## Narcotic

### B-3521 WD

Outside H 35.3", W 22.3", \*D 22"  
 Inside H 34.5", W 21.5", D 20.8"  
 Weight 380 Lbs.  
 Slot/Tray 4

\*(Add 2" for handle and dial lock)



### UC-0810C

Outside H 8", W 10", \*D 12"  
 Inside H 7.5", W 9.5", D 10"  
 Weight 31 Lbs.

\*(Add 2" for handle and dial lock)



\*Comes with LaGard Dial

### B 1414

Outside H 14", W 14", \*D 14"  
 Inside H 13.5", W 13.5", D 11.5"  
 Weight 88 Lbs.

\*(Add 2" for handle and dial lock)



### B 3018

Outside H 30.5", W 19.6", \*D 18.6"  
 Inside H 30", W 19", D 15.5"  
 Weight 245 Lbs.  
 Shelf 2

\*(Add 2" for handle and dial lock)



### B 1220

Outside H 12", W 20.5", \*D 20"  
 Inside H 11.8", W 20.2", D 16"  
 Weight 123 Lbs.

\*(Add 2" for handle and dial lock)



### B-4019

Outside H 40", W 19", \*D 22"  
 Inside H 39.5", W 18.5", D 21"  
 Weight 357 Lbs.  
 Shelf 4

\*(Add 2" for handle and dial lock)



### B 2020

Outside H 20.5", W 20.5", \*D 20"  
 Inside H 20", W 19.6", D 17"  
 Weight 194 Lbs.  
 Shelf 1

\*(Add 2" for handle and dial lock)



### B-5028

Outside H 50", W 28", \*D 31.5"  
 Inside H 49.5", W 27.5", D 30."  
 Weight 723 Lbs.  
 Shelf 4

\*(Add 2" for handle and dial lock)



## Additional Lock Option for B series

- LP Electronic
- S+G 6730 Combination
- S+G Key locking Dial
- LP EL-25 Time Delay
- LP EL-30 Dual custody
- LaGard Basic
- LaGard Safe Gard



# UNDER COUNTER

## Single Nose Key Lock UC-0612K

Outside H 8", W 6", D 12"  
 Inside H 6.8", W 5.5", D 10.2"  
 Weight 30 Lbs.  
 Deposit H 0.75", W 5.5"



## Single Nose Key Lock UC-1209K

Outside H 12", W 8", \*D 10"  
 Inside H 10.8", W 7.5", D 8.2"  
 Weight 34 Lbs.  
 Deposit H 0.75", W 6.5"



## Dual Nose Key Lock UC-0612KK

Outside H 8", W 6", D 12"  
 Inside H 6.8", W 5.5", D 10.2"  
 Weight 30 Lbs.  
 Deposit H 0.75", W 5.5"



## Dial Combination Lock UC-1209

Outside H 12", W 8", \*D 10"  
 Inside H 10.8", W 7.5", D 8.2"  
 Weight 34 Lbs.  
 Deposit H 0.75", W 6.5"

\*(Add 2" for Dial Lock)



\*Comes with LaGard Dial

## Single Nose Key Lock UC-1206K

Outside H 12", W 6", D 8"  
 Inside H 10.8", W 5.5", D 6.2"  
 Weight 30 Lbs.  
 Deposit H 0.75", W 5.5"



## Dial Combination Lock UC-0810CS

Outside H 8", W 10", \*D 12"  
 Inside H 7.5", W 9.5", D 10"  
 Weight 31 Lbs.  
 Deposit H 0.5", W 6"

\*(Add 2" for Dial Lock)



\*Comes with LaGard Dial

## Dual Nose Key Lock UC-1206KK

Outside H 12", W 6", D 8"  
 Inside H 10.8", W 5.5", D 6.2"  
 Weight 30 Lbs.  
 Deposit H 0.75", W 5.5"



## Safety Deposit Box Key SDB-200

Outside H 10", W 10", D 6"  
 Inside H 9.2", W 9.2", D 5.5"  
 Weight 14.5 Lbs.  
 Deposit H 0.5", W 9.6"



# WALL SAFES

- Designed to fit between the wall studs.
- Constructed of heavy gauge steel plate

## WS-1514C / WS-1514E

Outside  
Inside  
Weight  
Shelf

H 15", W 16", D 4"  
H 13", W 13.8", D 3"  
30 Lbs.  
1



WS-1514C



WS-1514E



## SFW-52EN-4 / 52EN-6

- Electronic lock with digital keypad
- Manual override key
- Uses 4 AA batteries with low battery warning signal
- Predrilled holes with mounting bolts
- 4" deep for SFW-52EN-4 & 6" deep for SFW-52EN-6

Outside  
Inside  
Weight  
Shelf

H 20.7", W 13.8", D 3.7" / 6"  
H 20.3", W 13.4", D 3.4" / 4.5"  
38 / 42 Lbs.  
2



SFW-52EN-4



SFW-52EN-6

# IN-FLOOR SAFES

## Common Features

- Door constructed of 1/2" thick A36 steel plate
- An additional independent spring-loaded reloading device, activated by a punching attack for models B1500 and above
- Body-"B" rate construction with large storage capacity and flush cover plate for total concealment under a carpet.
- 1/4" exterior bottom flange and powder coat
- UL group II 3-wheel combination lock

## Hinges Spring

HS-101



## Dial / Digital Lock

FS-1014C / 1014E

Outside A 14.84". B 9.57". C 10.06".  
 Inside C 9.3". B 9". A 9.7",  
 Weight 48.4 Lbs.

*Supplied with S+G combination or LP electronic Lock*

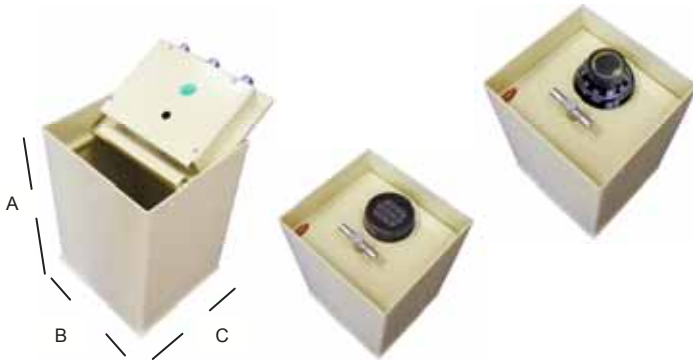

## Dial / Digital Lock

FS-1014S

Outside A 14.84", B 9.57, C 10.06"  
 Inside A 9.7", B 9", C 9.3"  
 Weight 48.4 Lbs.

*Supplied with S+G combination or LP electronic Lock*

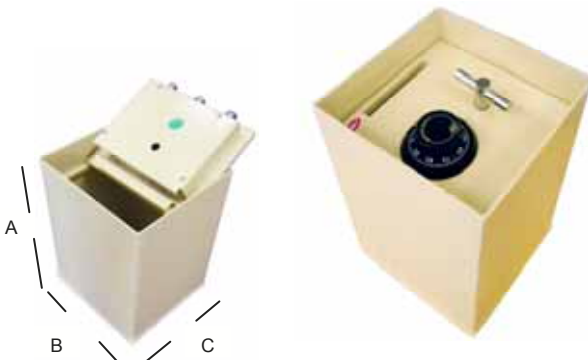

## Dial / Digital Lock

Lock

B 1600 / 1600S

Outside A 16.4", B 12.8", C 14.6"  
 Inside A 11.3", B 12", C 14"  
 Weight 106 Lbs.  
 Deposit H 0.5", W 5.5"

*Supplied with S+G combination or LP electronic Lock*

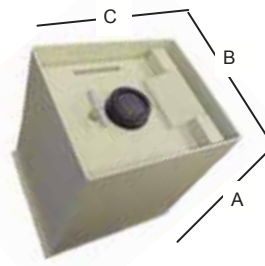

B 1600

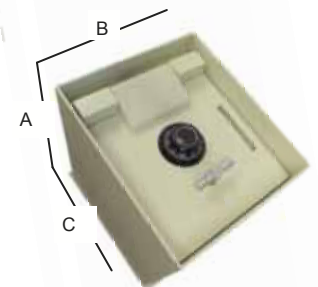

B 1600S

## Dial / Digital Lock

B 1500C / 1500E

Outside A 12.75", B 14.6", C 12.7"  
 Inside A 8", B 14.2", C 11.9"  
 Weight 104 Lbs.

*Supplied with S&G combination Or LP electronic Lock*



B 1500E

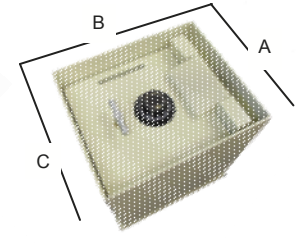

B 1500C

## Dial / Digital Lock

B 1806C / 1806E

Outside A 9", B 12.7", C 19"  
 Inside A 6", B 12.3", C 18.5"  
 Weight 110 Lbs.

*Supplied with S&G combination Or LP electronic lock*



B 1806E

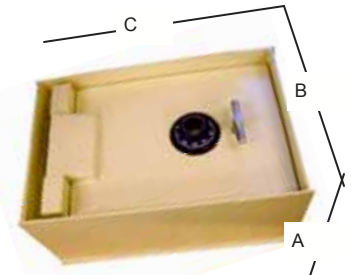

B 1806C

# POLYETHYLENE IN-FLOOR

## Common Features

- Interchangeable Door
- 1/2" Solid steel door w/large stainless steel flat locking system
- Patented, spring-assisted lift-off door
- Patented polyethylene body is rustproof and leak resistant
- Dual relock system
- Drill resistive hard plate
- UL listed combination lock
- Carpeted floor
- 1/4" thick door collar bolted to the body on all 4-sides using specially hardened bolts
- 1/2" thick door frame welded to the door collar
- Versatile storage system
- Protection against Fire, Burglary & Leakage
- False floor for FS-4000B

### DIAL COMBINATION LOCK

FS-2300B

Outside: H 15", W 18.5", D 15.5"  
Inside: H 12", W 17", D 12.25"  
Weight: 80 Lbs.  
Capacity: 1.5 cub. feet

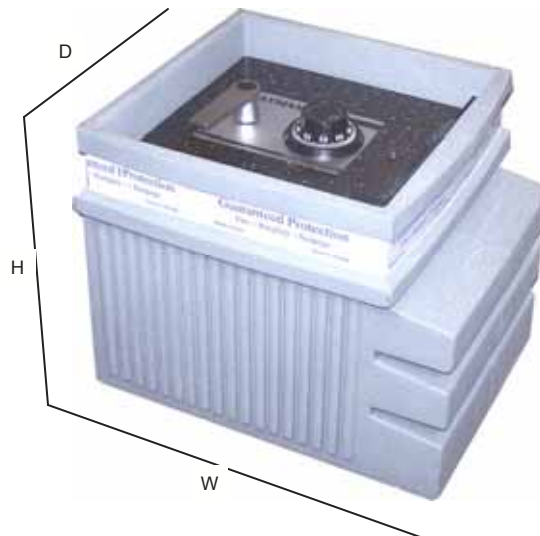

### DIAL COMBINATION LOCK

FS-4000B

Outside: H 20.25", W 21.8", D 15.5"  
Inside: H 17.25", W 20.25", D 12.5"  
Weight: 86 Lbs.  
Capacity: 2.5 cub. feet



# HOTEL AND ELECTRONIC SAFES

## ED Series Common Features

- Inside battery lock with illuminated LCD display
- Easy to program 3-8 digit access code
- 4-Pre-drilled mounting holes w/mounting bolts
- Attractive powder coated dark grey paint
- Override key

### Cross Key Lock SFT-22K

- Powder coated steel construction
- Predrilled mounting holes with mounting bolts
- Supplied with 3 cross style keys

Outside H 6.5", W 12.5", D 10"  
 Inside H 6", W 12", D 8"  
 Weight 18 Lbs.



### Cross Key Lock SFT-25K

- Solid steel construction
- Durable powder coat finish
- Predrilled mounting holes
- Supplied with 3 cross style keys and r

Outside H 10", W 14", D 10"  
 Inside H 9.6", W 13.6", D 8"  
 Weight 28 Lbs.



### Digital Lock SFT-45EDL

Outside H 10", W 17.7", \*D 14.4"  
 Inside H 9.5", W 17.3", D 12.4"  
 Weight 38 Lbs.  
 Shelf 1  
 \*(Add 1.5" for the digital lock)



### Digital Lock w/Audit HDC-719

- 3/4" Double locking bolts
- Easy to program 4-8 digit access code
- Manual override key & external Power supply for emergency
- Check door opening records
- Use 4 "AA" inside batteries

Outside H 8", W 20", D 14.8"  
 Inside H 7.7", W 19.5", D 12"  
 Weight 41 Lbs.



### Digital Lock (Mini Safe)SFT-18ENP

- Easy to program 3-8 digit code
- Pre-drilled holes w/mounting bolts
- Manual override key w/2 keys supplied

Outside H 7", W 11", D 7"  
 Inside H 6.6", W 10.6", D 5.8"  
 Weight 10 Lbs.



### Digital Lock SFT-12EBD

- Easy to program 3-8 digit code
- 4 x "AA" batteries & manual override key
- Powder coated finish
- Can be mounted in: Cabinets, Drawers, Vehicles, Walls, and Lockers

Outside H 5", W 12", D 14.5"  
 Inside H 3", W 11.5", D 14"  
 Weight 25 Lbs.



### Digital Lock SFT-25ED / 25EDM

Outside H 9.8", W 13.8", \*D 9.8"  
 Inside H 9.4", W 13.4", D 7.9"  
 Weight 22 Lbs.  
 Deposit H 0.25", W 6"  
 \*(Add 1.5" for the digital lock)



### Digital Lock SFT-36ED

Outside H 15", W 14", \*D 14.2"  
 Inside H 14.6", W 13.4", D 12.2"  
 Weight 35.6 Lbs.  
 \*(Add 1.5" for the digital lock)



# GIANT GUN SAFES

- Body & Door constructed from 12-gauge steel exterior
- Over 3/4 inch (.84) of steel between door and lock, including hardplate
- Body has a total of 2 pieces of 1/2 inch fire board for a total of 1 inch of fire board.
- Door has a total of 3 pieces of 1/2 inch fire board for a total of 1 1/2 inches of fire board.
- Door has fire-activated expanding door seal located on the door-frame on all four sides.
- Door bolts are 1 1/4 inches in diameter and are located on all 4 sides of the door.
- A total of 2 mounting holes sized 7/16 inch in diameter are located in the center of the safe's depth on the right and left sides.
- Dehumidifier access hole is 7/16 inch in diameter and located on the lower right hand corner of the back wall. Note that the fire board is not pre-drilled.
- The interior of the safe, the shelves, and the door back cover are all upholstered.
- Interior shelving are upholstered wood.
- Safe is U.L. listed as a RSC labelled safe.
- **1 Hour fire rating at 1200 degrees.**



RSC



## 16 Rifles

EV-5922

Outside H 59", W 22", D 16"  
 Inside H 56.5", W 19.5", D 12.5"  
 Weight 385 Lbs.

\*(Add 2 3/4" for handle)



## 24 Rifles

EV-5930

Outside H 59", W 30", D 24"  
 Inside H 56.5", W 27.25", D 20.25"  
 Weight 605 Lbs.

\*(Add 2 3/4" for handle & dial lock)



## 33 Rifles

EV-5939

Outside H 59", W 39", D 24"  
 Inside H 56.5", W 36.5", D 20.25"  
 Weight 740 Lbs.

\*(Add 2 3/4" for handle & dial lock)



# GIANT FB SERIES GUN SAFES

- Door: Fully fire proof insulated, 4 1/3" overall thickness including facial 1/4" steel plate, 1/8" middle steel plate, and 1/8" inner steel plate
- Body: 1/8" steel plate used for both inner and outer steel plates, plus 16 Gauge Reinforcement steel bracket added with 1-1/4" thick fire proof insulated construction
- Interior: Flexible design upholstered inside walls, shelving and door cover panel
- 1-1/4" dia chrome plated steel locking bolts
- 1-1/4" dia chrome plated dead bolts
- Glass relocking device
- Spring loaded auxiliary relocking
- 1/4" thick drill resistant harden plate (Ball bearing harden plate )
- Side punch attack resistant bolt work and 6 mm thick V shaped harden brackets
- Four recessed bolt down holes with plastic caps
- Expandable in-tumescent fire seal on 4 sides of door

## 15 Rifles

FBG-6022E

Outside H 59.3", W 22", D 20"  
 Inside H 54", W 19.2", D 12.8"  
 Weight 770 Lbs.  
 Shelf 2



RSC



## 24 Rifles

FBG-6030E

Outside H 59.3", W 31.4", D 22.4"  
 Inside H 54.5", W 26.9", D 16.5"  
 Weight 995 Lbs.  
 Shelf 4



RSC



## 32 Rifles

FBG-6036E

Outside H 59.3", W 36", D 26"  
 Inside H 54.5", W 31.3", D 20.1"  
 Weight 1187 Lbs.  
 Shelf 4



RSC



## 35 Rifles

FBG-6636

Outside H 66", W 36", D 28"  
 Inside H 61", W 33", D 20"  
 Weight 1373 Lbs.  
 Shelf 5



RSC



Not all Shelves shown in picture

# SAFE LOCKS

## LaGard Basic II Electronic Lock Kit

### Basic 3802 Firmware

#### Product Features

- Super Master Reset
- Manager Mode
  - Manager and One User Combination
- Wrong Try Penalty
- Dead Bolt or Swing Bolt
- Low Battery Signal
- UL, EN1300, VdS, DNV Certified

Item #	Description
3715 SC	Angular Round Entry - Satin Chrome (Battery behind keypad)
3715 TB	Angular Round Entry - Black (*Optional) (Battery access at bottom of keypad)
3715 BR	Angular Round Entry - Bright Brass (*Optional) (Battery access at bottom of keypad)

4200 Lock w/Manager & 1 User

3715-4200 LG Basic Kit



## LG Audit (66E) Electronic Lock Kit

### AuditGard 66E Firmware

#### Product Features

- Manager Mode
- External Connection for Audit Trail  
Optional Audit Interface Required
- Internal Bolt Switch
- User Status Signal
- Wrong Try Penalty
- Signal to Disable Lock Opening  
- Optional Alarm Box Required
- UL, EN 1300, VdS, DNV Certified.
- Time Delay - Key Pad or PC Programmable  
- Delay Period: 1-99 Minutes  
- Open Period: 1-19 Minutes

- External Emergency Power Terminals

#### PC Programmable Features

- Multiple Users - Up to 9  
- 1 Manager and 8 Users
- Time Delay Override (User 9)
- Silent Signal Alarm  
- Optional Alarm box required.
- Signal to Disable All Lock Functions  
- Optional Alarm Box Required
- Dual Token (Factory Programming Required)  
- E Key or E Key II

Item #	Description
3750K	LG Audit Round Entry—Satin Chrome
3125	LG Audit SC pin & spring Key Pad
6040-DB	Dead bolt lock w/control, manager, 8 users, dual code, audit trail, time delay & override, alarm silent & disable
4300-39E	Dual Handed Swingbolt
3122	e-Key Assembly

## LaGard ComboGard Pro (39E) Electronic Lock Kit

### ComboGard Pro 39E Firmware Product Features

- Manager Mode
  - Manager and Nine Users
- Wrong Try Penalty
- 63 Audit Events
- Lock may be set up either through Key Pad or PC Software (sold separately)
- Manager (Setup and Audits)
- Nine Users
- Time Delay  
- Delay Period: 1 – 99 minutes  
- Open Period: 1 – 19 minutes
- Time Delay Override (User 9)
- Dual Code Mode
- Silent Signal Alarm  
- Optional Alarm Box required (sold separately)
- Remote Override Signal  
- Optional Alarm Box required (sold separately)
- UL, EN1300, VdS, DNV certified  
The use of a Large Battery Box is recommended if Time Delay is operational

Item #	Description
3125	ComboGard Pro Round Entry
6040-DB	Knob Lock Deadbolt w/Manager, 1 User, (time delay, dual code, time delay & override, alarm silent and disable)
4300-SB	Swing Bolt Lock (w/ Manager, User, time delay, dual code, alarm)



## Override Redundant Locks

Item #	Description
6441-66E	66E 4 Wheel Override Lock
6441-39E	39E 4 Wheel Override Lock

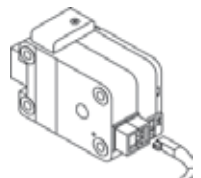

## Recommended Keypad for use with LG Basic II





# SAFE LOCKS

## LG Smart Link Series - Electronic Lock Kit

### SmartLinc II

- Serial Access Control
- Multi-User, Multi- Compartment Control
- Audit Trail
- Time Delay
- Time Lock

The Smart Series offers a range of features: multiple master codes, 8-98 users, user role assignment and the ability to manage up to five locks from a single logic module.

Accountability is more than a deterrent; it's the strongest weapon available to prevent internal theft. The Smart Series provides accountability through indisputable audit information. The advanced features of SmartLinc II and SmartPoint offer up to 4000 audit events in each lock and 1000 system events at the logic module.

Ensuring your employees' safety and security is paramount. Features like the Silent Signal Duress Alarm, Time Lock scheduling and Time Delay allow for time controlled access and warnings to be sent in the event of a robbery.

Item #	Description
9150	Smartlinc II Logic module
4300 7B	Dual-Handed Swing Bolt Lock
4001	Large battery box
2041	Logic module cable
701105	Lock programming cable
707000	Software
6040 7B	Smartlinc II Dead Bolt Lock
6034 7B	Spring Bolt Lock (w./o sensor)
6441-7B	Smatlinc II Override lock



## LaGard Dials and Rings

Item #	Description
2085-SC	VisionGard Dial & Ring
2090-SC	VisionGard Key-Locking Dial & Ring
1777	FlatGard Dial & Ring
1779	FlatGard Key Locking Dial & Ring
2107	Small Dial & Dial Ring, Satin Chrome
2107-BK	Smale Dial & Ring—Black

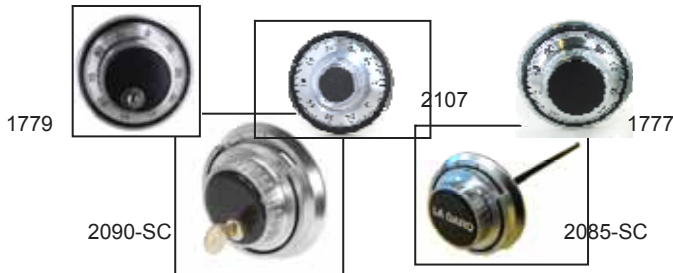

## Battery Boxes

Item #	Description
2788	Small Battery Box
4001	Large Battery Box Standard



## LG Key Lock Assembly

Item #	Description
2270	Key Lock
2226	Key Hole Cover
2212-02	3" keys, random cut, (Pair)
2217-02	4" keys, random cut, (Pair)
2218-02	5" keys, random cut, (Pair)
2242-1-2	6" Keys, random cut, (Pair)
2280	Key extension handle, 12"
2282-02	Key tips, Random cut, pair
2213	Setup key



2270



2226



2242-1-2

## LaGard Mechanical Combination

Item #	Description
3390	Group 2M—3 Wheel Lock
1985	Group 1—3 Wheel Lock
1947	Group 1—4 Wheel Lock



## Original S&G Dial & Lock

Item #	Description
6730	Group 2M—3 Wheel Lock
D300 / R211	Dial & Ring
D225-013/R167-13	SG Dial & Ring w/key & spy proof
6630	Group 2M— 3 Wheel Lock



D225-013

6630

R167-13

D300

R211

6730

# KEY CONTROL

## Combination Lock

**Item #**  
**PR-CL**

**Description**  
Combination Lock used in DKC cabinets



## Combination Lock

**DKC - 20**

- 20—Capacity Key Cabinet  
Outside H 8", W 6.3", \*D 3.2"  
Weight 3 Lbs  
\*(Add 0.5" for the lock)



## Key Lock

**KC—20**

- 20—Capacity Key Cabinet  
Outside H 8", W 6.4", D 3.2"  
Weight 2 Lbs.



## Combination Lock

**DKC - 46**

- 46—Capacity key Cabinet  
Outside H 11.8", W 9.5", \*D 3.2"  
Weight 5 Lbs  
\*(Add 0.5" for the lock)

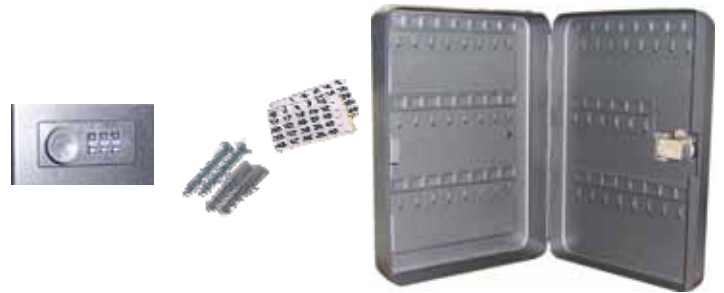

## Key Lock

**KC—48**

- 48—Capacity Key Cabinet  
Outside H 12", W 9.6", D 3.2"  
Weight 4 Lbs.



## Combination Lock

**DKC - 94**

- 94—Capacity Key Cabinet  
Outside H 11.8", W 9.5", \*D 3.2" \*(Add 0.5" for the lock)  
Weight 7 Lbs



## Key Lock

**KC—96**

- 96—Capacity Key Cabinet  
Outside H 12", W 9.6", D 3.2"  
Weight 5.5 Lbs.



# KEY CONTROL

- Scratch & corrosion resistant epoxy powder coat paint
- Heavy gauge steel construction
- Anchoring holes & screws for easy installation
- Key control tags
- Numbered key control booklet for lock location data



Accessories

## Digital Lock **SFK-48EN(S)**

- 48 Key capacity
- Electronic lock to program with 3-8 numbers
- Manual override key
- Powder coated in & out
- Pre-drilled holes with mounting bolts
- With key drop slot

Outside H 14.3", W 11.8", D 3.9"  
 Weight 18 Lbs.  
 Slot H 2", W 1.25"



## Digital Lock **SFK-144EN(S)**

- 144 Key capacity
- Adjustable key racks
- Powder coated paint
- Heavy gauge steel construction
- Electronic lock with override key
- Opening for key deposit

Outside H 26", W 17", D 5.13"  
 Weight 47.4 Lbs.



## Key Lock **KC-145-8**

- 8—Capacity Key Cabinet

Outside H 6.6", W 5.75", D 2"  
 Weight 1.5 Lbs.



## Key Lock **KC-330-60**

- 60—Capacity Key Cabinet

Outside H 17", W 13", D 3.3"  
 Weight 6 Lbs.



## Key Lock **KC-205-30**

- 30—Capacity Key Cabinet

Outside H 12", W 8", D 2.5"  
 Weight 2.7 Lbs.



## Key Lock **KC-330-120**

- 120—Capacity Key Cabinet

Outside H 17", W 13", D 3.3"  
 Weight 6.6 Lbs.



# KEY CONTROL

- Heavy gauge steel construction
- Numbered key tags with key rings
- Lock location chart for easy reference
- 4-point mounting hardware and predrilled holes
- Continuous piano hinge
- Steel key—tag hooks

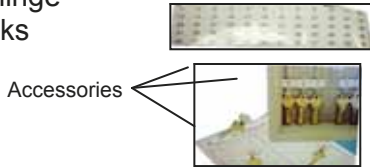

## Key Lock K 300

- 30—Key Capacity C/W Key Lock
- Outside H 12", W 8.1", D 3.2"  
Weight 5.5 Lbs.



## Key Lock K 600

- 60—Key Capacity C/W Key Lock
- Outside H 19.5", W 13.6", D 4.8"  
Weight 14.3 Lbs.



## Key Lock K 1200

- 120—Key Capacity C/W Key Lock
- Outside H 19.5", W 13.6", D 4.8"  
Weight 14.3 Lbs.



## EXTRA KEY TAGS FOR GE CABINETS

- | Item # | Description                  |
|--------|------------------------------|
| 001819 | Bag of 140 Assorted Key Tags |



## Pushbutton Lock QA 300

- 30—Key Capacity C/W QuickAccess Lock
- Outside H 12", W 8.1", \*D 3.2"  
Weight 5.5 Lbs.  
\*(Add 0.5" for the lock)



## Pushbutton Lock QA 600

- 60—Key Capacity C/W QuickAccess Lock
- Outside H 19.5", W 13.6", \*D 4.8"  
Weight 14.5 Lbs.  
\*(Add 0.5" for the lock)

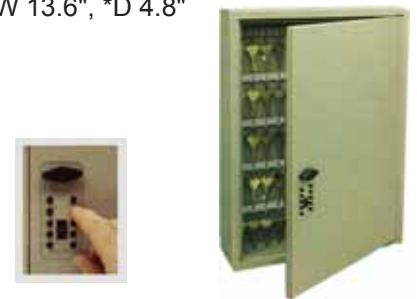

## Pushbutton Lock QA 1200

- 120—Key Capacity C/W QuickAccess Lock
- Outside H 19.5", W 13.6", \*D 4.8"  
Weight 14.5 Lbs.  
\*(Add 0.5" for the lock)



## TouchPoint Lock (Clay) 001798

- Description  
Outside: H 3.5", W 1.75", D 1"  
Weight 1 Lbs



# KEY CONTROL



## Push Lid Portable KeySafe (Clay colour)

### Description

Outside: H 5.75", W 4.44", D 1.8"



## Dial Lid Portable KeySafe (Black colour)

### Description

Outside: H 4, W 2.5", D 1.4"  
 Inside: H 2.75", W 1.6", D 1.1"



## KeySafe Original Permanent (Assorted) 001001

### Description

Outside: H 4", W 2.5", D 2"  
 Inside: H 2.75", W 1.5", D 1.25"



White

Titanium (Gray)

Clay

## KeySafe Auto Window Mount (Black colour)

001003

### Description

Outside: H 3.75", W 2.5", D 1.5"  
 Inside: H 2.75", W 1.75", D 1.25"



## KeySafe Original Slimline (Assorted) 001004

### Description

Outside: H 3.9", W 2.25", D 1.5"  
 Inside: H 2.7", W 1.5", D 0.8"



White

Titanium (Gray)

Clay

## Push Lid Portable KeySafe (Titanium colour)

001095

### Description

Outside: H 4.25", W 3.5", D 1.75"  
 Inside: H 2.75", W 1.5", D 1.4"



## KeySafe Professional 002045 / 002046-P500

- Solid metal construction
- Stainless steel security liner
- 4096 Possible combination codes
- Store 5+ keys
- Weather cover & hardware included
- **Alarm Interface for 002046-P500**
- Dimensions: 3.2" x 5.8"x2.5"
- Weight: 4 Lbs



002045-P500



002046-P500

## KeySafe Accessories Black Cover 081553

### Description

Outside: H 4.5", W 2.5", D 2"



Slimline Cover

## KeySafe Pro (Black colour)

### Description

Outside: H 4.8", W 3.5", D 2.75"  
 Inside: H 3.75", W 2.25", D 1.75"



For Orders: safes@knells.ca  
 1.519.578.1000 ext 400

# CASH DRAWERS / CASH BOXES

## Pushbutton and Key Lock

CD-1616P

- Manually operated cash drawer with front pushbutton
- 5 drawers for bills & 8 for coins
- 2 function lock: Locked open and Locked closed/opened
- Available in beige or black
- 2 keys included
- Roller bearing suspension system provides long lasting performance
- Latch ejection mechanism tested over one million cycles to ensure a longer lasting drawer

Outside Weight H 4.3", W 16.2", D 16.5"  
16 Lbs.



Available in Beige or Black

- The key lock provides 2 functions: locked open, and locked closed/opened
- The key may be removed in the 12 o'clock (Locked Open), or 3 o'clock (Locked Closed) positions.

## Key Lock

CD-1616K

- Dual media slot cash drawer
- Electronically activated with interface cable connected to sale receipt printers or terminals
- Solenoid works with 24V DC
- 5 drawers for bills & 8 for coins
- 4-function lock to offer several levels of security: Locked closed, locked open, on line, manual open
- 2 keys are included
- Available in beige or black

Outside Weight H 4.3", W 16.2", D 16.5"  
16 Lbs.



Available in Beige or Black

The roller bearing suspension system provides long lasting performance

## Pushbutton and Key Lock

MK-410M

- 3-position lock :locked, manual open and electrically online
- 4-Bill with Metal wire grips, & 8 Adjustable Coin Slots
- Thick gauge cold rolled steel & SECC
- Textured hybrid powder coat
- Polyurethane for smooth operation

Outside Weight H 4", W 16.13", D 16.65"  
17.2Lbs.



## Key Lock

BC-CD520

- Single media slot cash drawer
- Electronically activated with interface cable connected to sale receipt printers or terminals
- Solenoid works with 24V DC
- 5 drawers for bills & 8 for coins
- 4-function lock to offer several levels of security: Locked closed, locked open, on line, manual open
- 2 keys are included
- Available in black

Outside Weight Deposit H 4", W 19", D 16.25"  
20 Lbs.  
H 1/4", W 7.25"

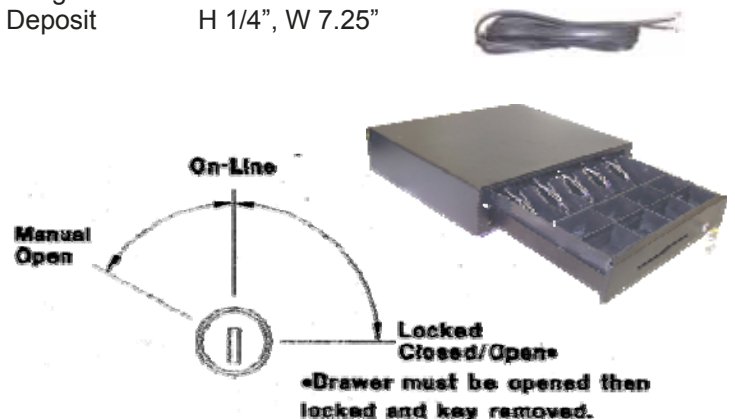

# CASH BOXES

## Coin Bank

Item#	Description
DCB-002(S)	Small money bank w Comb lock & Slot
DCB-002	Small money bank w Comb lock
C300M	Small money bank w Key lock

- Powder coated steel construction
- Outside H 7.25" W 4.75" , D 4"



DCB-002



Available in cow print or solid silver

Small white tray inside to catch coins



Coin Slot on top



DCB-002(S)

## Combination Lock

DCB-002

- Inside with 3 - panels plastic tray
- Easy to change combination dial lock

Outside H 3.5", W 7.9", D 6.3"  
Weight 3 Lbs.



## Key Lock

C - 300M

- Plastic tray for organizing cash
- 2 panels for paper currency & 3 panels for coins
- Made of quality pressed steel + epoxy powder coating

Outside H 3.5", W 12", D 9.5"  
Weight 4 Lbs.



# BRAWN PADLOCKS

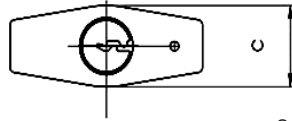
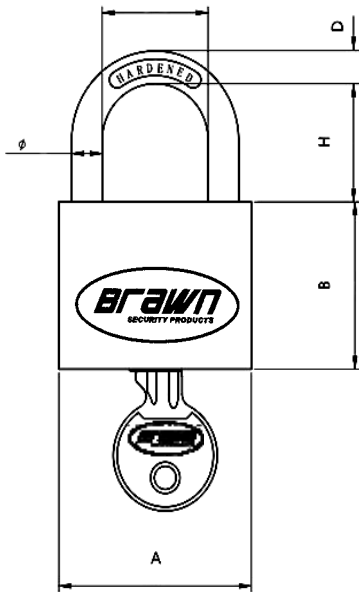

Solid brass body

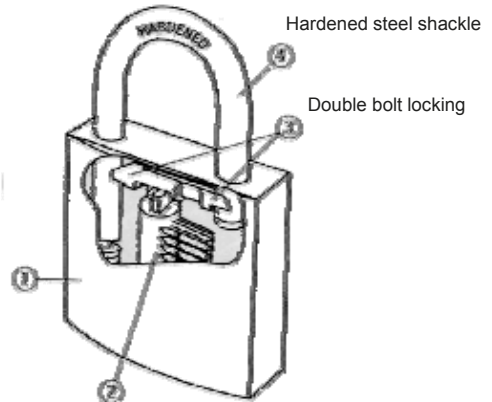

- Anti picking mushroom pins
- Stainless steel & brass inner mechanism for smooth operation in bad weather conditions



BR-40 KA



BR-50 KA-LS



BR-40 KD



BR-40 KD-LS



BR-30 KA

- **BR Padlock Series come with KD Blistered and KA Boxed**

Model #	A	B	C	H	D
BR-30 KD / KA	30	28.5	14	17	4.76
BR-40 KD / KA	40	33	15.8	23	6.35
BR-40 KD-LS / KA-LS	40	33	15.8	40	6.35
BR-50 KD / KA	50	40.5	18.5	30	7.95
BR-50 KD-LS / KA-LS	50	40.5	18.5	50	7.95





# NEW BRAWN DISC PADLOCKS BR-26/70 KA & KD

Hardened chrome shackle



Stainless steel body

Anti-pick mushroom pins

Product may not be exactly as shown

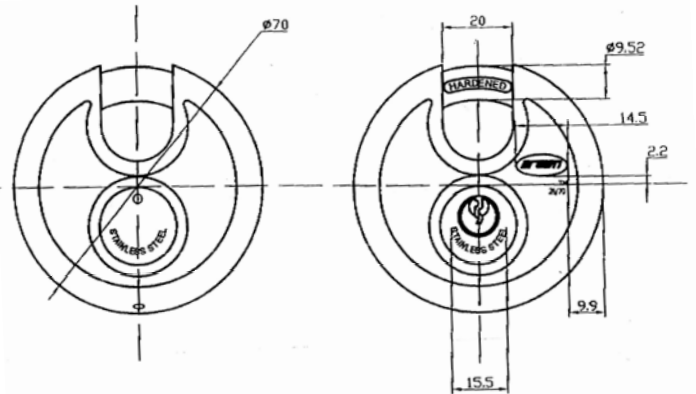

List Price	Packing	A	B	C	H	D
BR-26/70 KA	Boxed	70	42	32	17	9.5
BR-26/70 KD	Blister	70	42	32	17	9.5

## BRAWN KEY TAGS AND SPLIT RINGS

### SMALL KEY TAGS

BRTG-1

Available in:  
White, Yellow, Purple, Red, Blue, Green, and Black



### LARGE KEY TAGS

BRTG-2

Available in:  
White, Yellow, Purple, Red, Green, Orange and Blue



### GIVEAWAY KEY RINGS

Item #  
3/4"  
1"

Description  
Small Key Ring  
Large Key Ring



# KEY BLANKS

## BOOIL KEY BLANK

Item #	Description
BO-1	Old Style Round Head
BO-2	H.S. New Style Square Head

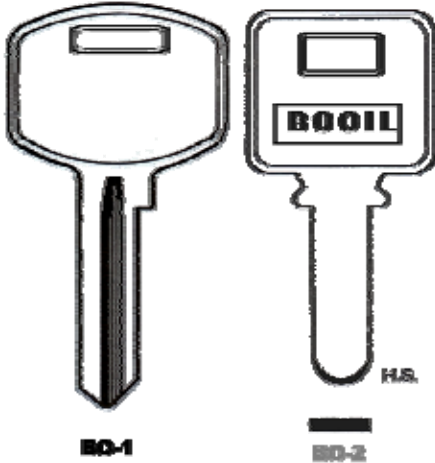

BO-1 : Discontinued  
BO-2

## CROSS KEY BLANK

Item #	Description
CR01	Blank for SFT-25MC, SFT-25K, SFT-22K & HDC-719 Safes

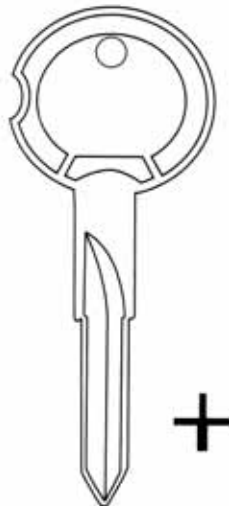

## KEY CABINET AND CASH BOX KEY BLANKS

Item #	Description
KC1	For Key Cabinets: KC-20, KC-48, KC-96
KC2	For Key Cabinets: KC-145-8, KC-205-30, KC-330-60, KC-330-120
	*Some cabinets are changing to the KC-4 blank
KC4	For Key Cabinets: KC-145-8, KC-205-30, KC-330-60, KC-330-120
	*New keyway plastic head
CB1	Fits C-300M Cash Box



## SAFE DEPOSIT MJWA INC.

Item #	Description
MJ1	MJWA OPERATING KEY
MJ2	MJWA PREPARATION KEY



## BRAWN PADLOCK KEY BLANKS

Item #	Description
PAD-30	Fits 30 mm Padlocks
PAD-40	Fits 40 mm Padlocks
PAD-50	Fits 50 mm Padlocks



**NOTES:**

---

**Terms and conditions:**

- Payment is due within 30 days of invoice date to customers with approved credit —2% will be charged for overdue accounts
- We accept Interact, Visa and Master Card payments “**at time orders are processed only**”.
- All prices are subject to HST
- All merchandise, F.O.B GIANT SAFE’s warehouse unless otherwise stated.
- GIANT SAFES reserves the right to alter the specifications, pricing and withhold shipment to accounts that don’t meet our payment terms without prior notice.

**Damages rules:**

- Our products are carefully packed and inspected before shipping.
- Inspect shipment upon receipt. If pieces are missing or in bad condition, note full information on freight bill and delivery receipt
- If the BUYER gives the carrier a clear receipt for a shipment, the carrier is relieved of further responsibility.
- open cartons immediately, if something is wrong call carrier and request an inspection, confirm this request in writing. Hold carton and unit for their inspection. This must be done within 15 days of delivery date.
- SELLER will not accept return of merchandise damaged in TRANSIT



**PHONE: 705-817-8144**

**FAX: 705-417-1583**

**EMAIL: [sales@giantsafes.com](mailto:sales@giantsafes.com)**

**WAREHOUSE LOCATIONS:**

**Vancouver BC**

**Toronto ON**

**[WWW.GIANTSAFES.COM](http://WWW.GIANTSAFES.COM)**